

**Lautsprecher LSM-66F** Art.-Nr.: 120090

**Specification :**

TYPE	UNIT	LSM-66F
Impedance	$\Omega$	8 $\pm$ 15%
Power (Nominal)	W	0.5
Power (Maximum)	W	1.0
Resonant Frequency	Hz	350 $\pm$ 20%
Sound Pressure Level	dB	88 $\pm$ 3
Frequency Range	Hz	Fo~4.000
Operating Temperature	$^{\circ}$ C	-10~+50
Storage Temperature	$^{\circ}$ C	-20~+60

**Dimensions :**

(Unit : mm)

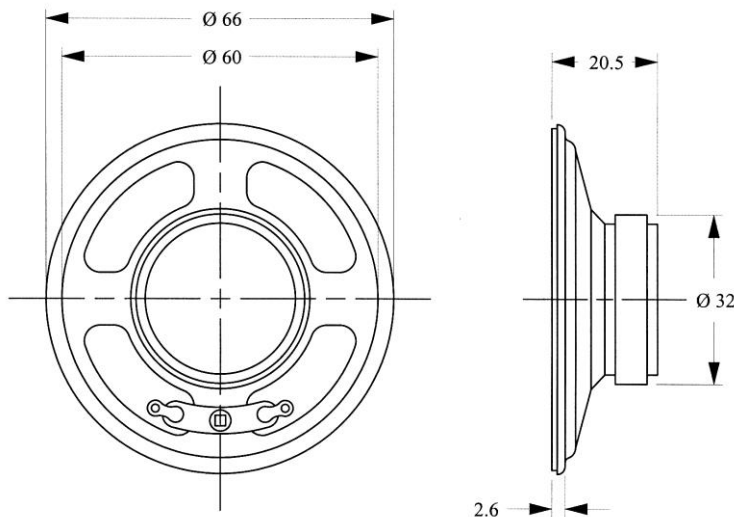

**Frequency Response :**

